

ELITE ELEVATOR



Contact Name: _____

Job Name: _____

Email Address: _____

Location: _____

Notes: _____

BASE PACKAGE

Includes 2 landings, 1 opening, cab model 3636 or 3648, winding drum drivetrain, 8lb. guide rails, travel cable, PLC controller and optical landing system, terminal and final limits, 2 recessed LED automatic cab lights, stainless steel fixtures with blue LED buttons, phone, standard flat wall cab finish, 1 door lock per level.

HOISTWAY

Hoistway Size	Rail Location	Landings						
<p style="text-align: center;">W X D</p>	<p style="text-align: center;">LEFT RIGHT</p>	<table style="margin: auto;"> <tr><td>2</td><td>5</td></tr> <tr><td>3</td><td>6</td></tr> <tr><td>4</td><td>7</td></tr> </table>	2	5	3	6	4	7
2	5							
3	6							
4	7							
Hoistway Construction								
Wood Concrete								

Note: Refer to Master Cab Configuration file for recommended standard hoistway sizes.

CAB

Cab Model	Cab Configuration	Cab Height
3636	Front Opening	6' 8"
3648	Pass Through	7' 0"
3660	90 degree opening	8' 0"
4254		
4836		

CAB FINISHES

Standard Flat Walls	Flat Wood Veneer	Traditional	Shaker Style
Finish	Unfinished	Unfinished	Finish
White	Birch	Birch	White
Beige	Oak	Oak	Unfinished Birch
Black	Cherry	Cherry	
Other	Mahogany	Mahogany	

Lights	
2 LED	4 LED









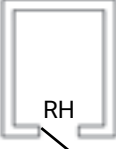
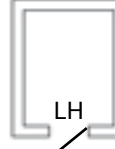
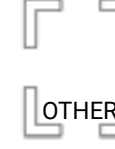
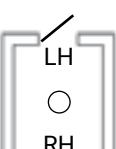
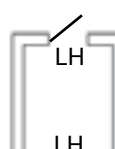
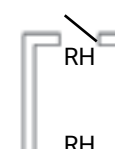

Fixture Finish

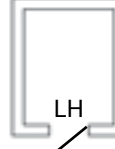
#4 Brushed Stainless
Bronze
Copper Vein

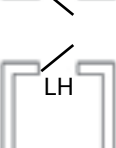
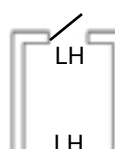
Fixture Shape

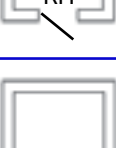
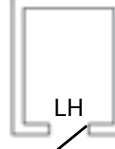
Traditional
Oval

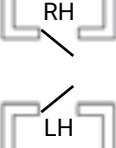
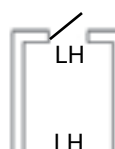
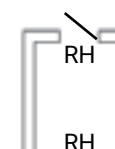
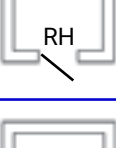
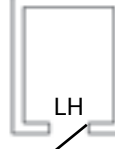
Select hoistway door configuration for each floor level.

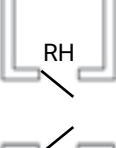
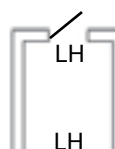
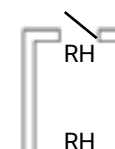
DOOR SWING	LEVEL 4			
				
	LEVEL 3			
				
	LEVEL 2			
				
	LEVEL 1			
				

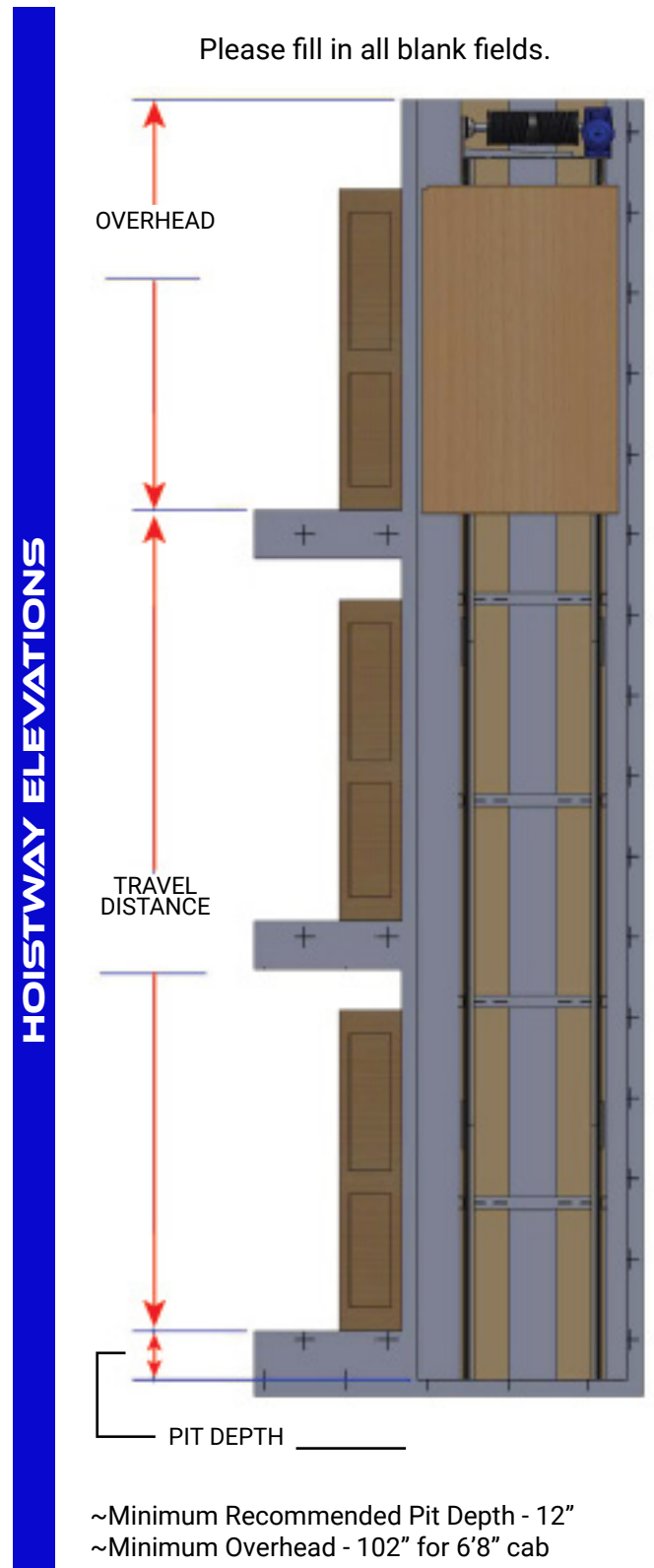

STANDARD FEATURES

- » PLC Based Controller, ETL Listed
- » Terminal and Final Limits
- » Optical Landing System
- » 2nd Level Homing
- » Blue LED Call Buttons
- » Automatic Cab Lights
- » Travel Cable
- » Cartop Box
- » Phone
- » 2 Drawing Revisions

OPTIONS

- Battery Lowering w/ e-light
- Additional Door Locks QTY _____
- Automatic Gate Operator QTY _____
- Security Keypad
- Float Switch
- Door Baffles QTY _____
- Custom Platform Size
- Excess Travel Distance _____
- Round Handrail
- Additional Drawing Revisions QTY _____

MACHINE ROOM

Controller/Machine Room Location:

- Adjacent
- Remote _____ feet
- Standard Travel Cable (hoistway length + 20ft)
- Extra Travel Cable
- Controller for Stops 5-7

DRIVE

- Winding Drum - 950 lb. capacity
- Roped Hydraulic

GATES

Standard Vinyl

- White
- Tan
- Gray

Wood Grain Vinyl

- Birch
- Maple
- Natural Oak
- Dark Oak

Unfinished

Natural Wood Veneer

- Birch
- Maple
- Oak
- Mahogany
- Cherry

Acrylic

- Clear

OPTIONAL DOOR JAMBS

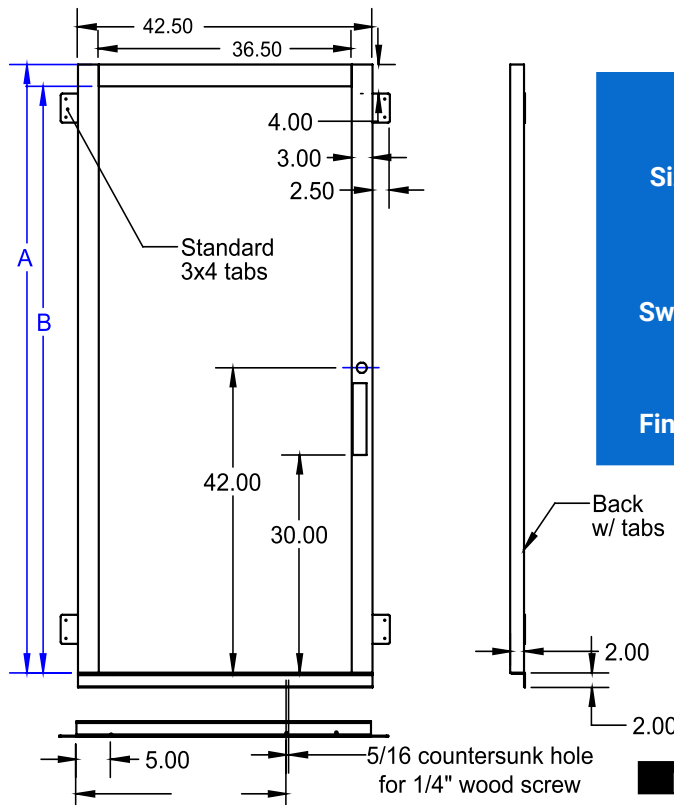

	Quantity
Size	80" _____
	84" _____
	96" _____
Swing	Right _____
	Left _____
Finish	White _____
	Beige _____



36" wide door panel provided by others. Integrated self closing hinge and honeywell realign door lock with LED call button. Strike plate kit included with frame.

Door Size	r/o Frame Size	A	B
36x80	44 x 84.5	83.75	80.75
36x84	44 x 88.5	87.75	84.75
36x96	44 x 100.5	99.75	96.75